

OWNER'S MANUAL

Öhlins Shock Absorber for MX/ Enduro/ Off Road



Before Installing

Safety Precautions

Öhlins Racing AB cannot be held responsible for any damage to the shock absorber or vehicle, or injury to persons, if the instructions for installing and maintenance are not followed exactly.

Similarly the warranty will become null and void if the instructions are not followed.

NOTE!

Öhlins products are subject to continuous improvement and development. Therefore, although these instructions include the most up-to-date information available at the time of printing, there may be minor differences between your shock absorber and this manual. Please consult your Öhlins dealer if you have any questions regarding the contents of the manual.

Before riding the vehicle, always make sure that the basic settings made by Öhlins are correct. See the Mounting instructions for recommended Set-up data. Contact an Öhlins dealer if you have any questions about setting the shock absorber.

Safety Signals

In this manual, mounting instructions and other technical documents, important information concerning safety is distinguished by the following notations:



The Safety alert symbol means: Warning! Your safety is involved.

▲ WARNING!

The Warning symbol means: Failure to follow warning instructions can result in severe or fatal injury to anyone working with, inspecting or using the shock absorber, or to bystanders.

CAUTION!

The Caution symbol means: Special precautions must be taken to avoid damage to the shock absorber.

NOTE!

The Note symbol indicates information that is of importance regarding procedures.

▲ WARNING!

Installing a shock absorber, that is not approved by the vehicle manufacturer, may affect the stability of your vehicle. Öhlins Racing AB cannot be held responsible for any personal injury or damage that may occur after installing the shock absorber.

Please study and make certain that you fully understand this manual and the mounting instructions before handling this shock absorber. If you have any questions regarding proper installation procedures or maintenance, please contact an Öhlins dealer.

Refer to the vehicle service manual when installing this shock absorber.

© Öhlins Racing AB. All rights reserved. Any reprinting or unauthorized use without the written permission of Öhlins Racing AB is prohibited. Printed in Sweden.

Öhlins Racing AB

The Story

Öhlins Racing AB

It was the 1970's, a young man named Kenth Öhlin spent most of his spare time pursuing his favourite sport: motocross.

A careful observer, Kenth's attention was continually drawn to one specific detail - motocross bikes had more engine power than their suspension could handle. It was not long before Kenth realised that better performance could be achieved by improved wheel suspension.

Öhlins Racing was established in 1976, and just two years later the company won its first World Championship title. Despite being in the business for 30 years, the search for perfection and new functions is still the main focus of the company.

Congratulations!

You are now the owner of an Öhlins Shock Absorber. More than one hundred World Championships and other major world titles are definitive proof that Öhlins shock absorbers offer outstanding performance and reliability.

Every product has gone through rigorous testing and engineers have spent thousands of hours, doing their very best to use every possible experience from our 30 years within the racing sport.

The product that you now have in your possession is pure racing breed that is built to withstand. By installing this shock absorber on your vehicle you have made a clear statement... you are a serious rider with a focus on getting the maximal handling ability and outstanding feedback from your vehicle. Along comes the fact that your shock absorber will be a long lasting friend, delivering the very best of comfort and performance every time you go for a ride.

Go explore!

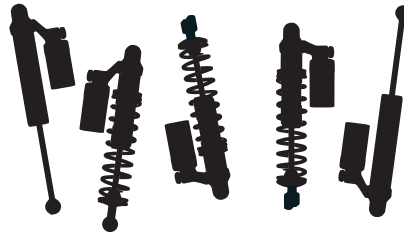

Contents

	pg
Before Installing	1
Öhlins Racing AB	2
The Öhlins Shock Absorber	
<i>Design</i>	4
<i>Function</i>	5
Adjustments	6
<i>Spring Preload</i>	7
<i>Rebound and Compression</i>	8
<i>High and low speed Compression</i>	9
<i>Ride Height and Free Sag</i>	10
Set Up Your Motorcycle	11
General Handling Set-up	12
Inspection and Maintenance	14

The Öhlins Shock Absorber

Design

Design

Most of Öhlins suspensions are a high pressure monotube type. The fluid is put under gas pressure and the gas and the fluid are kept apart by a separating piston. The piston is usually fitted in an external reservoir, connected by a hose (Fig. 1.4) or fixed directly on top of the shock absorber (Fig 1.3).

In some models everything is fitted inside the main shock absorber (Fig 1.2).

A few shock absorbers are of emulsion type, oil and gas mixed inside the shock absorber (Fig 1.1).

Pressurisation of the fluid is made with nitrogen. The pressurisation prevents cavitation of the fluid and the shock absorbing action is therefore more even. The external reservoir also contributes to better cooling of the fluid, giving longer service life for the fluid as well as the components.

Öhlins shock absorbers with external rebound adjustment have an integrated temperature compensation. As the temperature increases, and the fluid flows more easily, the flow is controlled accordingly. The shock absorbing effect is therefore independent of the temperature.

The more advanced models permit individual adjustment of compression and rebound damping.

Öhlins shock absorbers provide the possibility of adjustment, making them adaptable to most motorcycles, riders and ranges of use. All of the shock absorbers with springs have adjustable preload of the spring action.

Fig 1 Design types

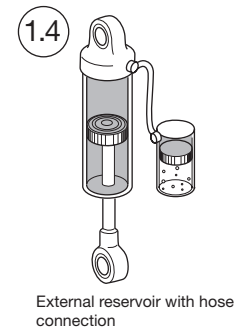
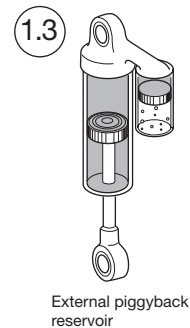
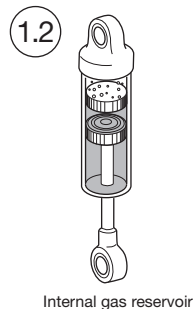
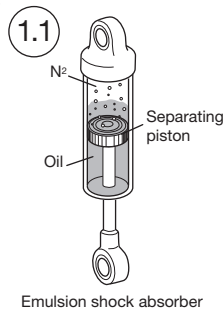

The Öhlins Shock Absorber

Function

Function

Fluid is forced through needle valves at a low rate of flow (Fig 6) and through a number of orifices in the piston (Fig 7) at a high rate of flow. The flow through these orifices is regulated by shims (thin steel washers) that at high pressure are deflected to open for the fluid. On most models the needle valve can be adjusted from the outside.

By altering the size of the shim-stack (Fig 8) (i.e. number, thickness, diameter) the characteristics of the damping action can be changed. *This should only be done by an authorized Öhlins service workshop.*

Compression damping

When movement of the motorcycle causes compression of the shock absorber, the fluid flows through the needle valve (combined compression and rebound valve) in the piston rod. If the velocity of the compression movement is high, i.e., in the case of rapid compression, this will not be sufficient and consequently the shims underneath the piston will open to allow for a greater rate of flow. The fluid that is displaced by the volume of the piston rod is forced into the external reservoir via a separate compression valve. The separating piston is displaced, thus increasing the gas pressure.

Fig 6 Flow through needle valve

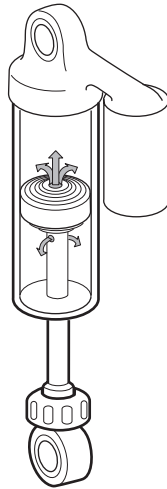

Fig 7 Flow through piston

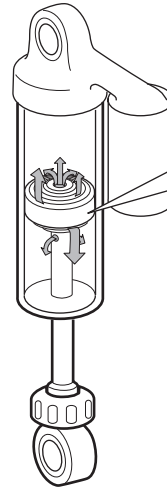
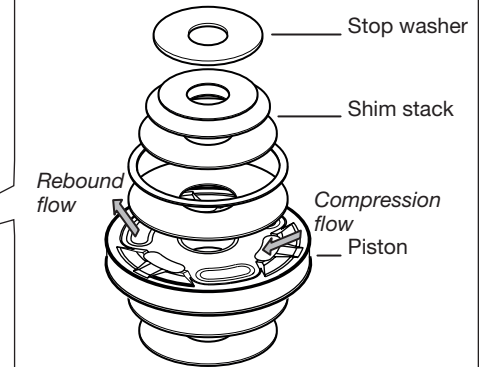

Fig 8 Shim stack



Rebound damping

When the spring forces the shock absorber to extend again, the fluid flows back through the needle valve. The fluid flowing into the chamber is forced by the pressure of the gas back into the shock absorber via a separate non-return valve. If the piston velocity is high, the shims on top of the piston will also open to allow the fluid to flow through.

Adjustments

General

Stability and traction

All motorcycles are designed with a suspension geometry that includes height and fork angle. The changing of components can affect this and it is therefore essential that both the front and the rear ends match each other.

Changing to Öhlins suspension gives optimum performance only when both the front fork and the rear suspension interact properly. It is very important that the front and the rear loaded heights are within the specified values.

Front Fork Springs

To optimize the stability and traction of your motorcycle the front fork must match the rear suspension. Öhlins Racing has a variety of front fork springs available for a large number of motorcycle models. The springs in combination with the Öhlins shock absorbers contribute to superior stability and traction. See the Öhlins Recommendation List by contacting your nearest Öhlins dealer or using our web site.

▲ WARNING!

If there are no matching spring for your motorcycle model, use the original springs, however, they must be in good condition and not fatigued. Change the oil in the front fork at least once every year. Contact an Öhlins dealer for recommended front fork oil.

▲ WARNING!

When delivered, the Öhlins shock absorber is dialed to the recommended settings for the specific brand and make of the motorcycle. Before riding, always ensure that the basic settings made by Öhlins are correct.

Always make notes, adjust in small steps and make only one adjustment at a time.

To set the adjuster:
(compression and rebound)

The turn adjusters have a normal right hand thread. Turn the damping adjusters clockwise to fully closed (position zero [0]). Then, turn counter clockwise to open, and count the clicks until you reach the recommended number of clicks. See Set-up data in the Mounting Instructions for the shock absorber.

Do not use force, delicate sealing surfaces can be damaged. Handtighten only.

Adjustments

Most Öhlins shock absorbers for motorcycle are equipped with spring preload, compression and rebound damping adjusters. Due to limited space in some vehicles it is not possible to have all adjusters in certain models.

The three adjusters mentioned above, will be discussed in the following chapters. A deeper understanding for the different types of adjustments will give you a good knowledge of how you can get better performance from your Öhlins shock absorber.

- **Spring preload** when adjusting the spring preload, you move the spring seat. This will lower or raise the ride height.
- **Compression damping** controls the energy absorption when the shock absorber is being compressed, thus controls how easy the shock absorber compresses when you hit a bump.
- **Rebound damping** controls the energy absorption when the shock absorber is being extended and, thus controls how fast the shock absorber returns to its normal position after being compressed.

Adjustments

Spring Preload

Spring Preload

The spring preload is fundamental for the function of the suspension. If the preload is incorrectly set, any other adjustments to the shock absorber will not help to get the intended performance from the suspension.

Öhlins shock absorbers are delivered with the spring preload carefully set for a good balance in the vehicle with a 80 kg or 175 lb. rider.

The spring preload is the difference between A and B;

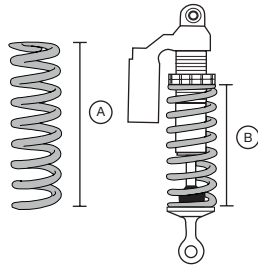

A Free spring length
B Installed spring length

$A - B = \text{Spring preload}$

Setting Spring Preload

- *Shock absorber with spring platform and lock nut:* Use a C-spanner. Turn the spring platform nut (A) to set the spring preload. Lock the setting with the lock nut (B).
- *Shock absorber with spring platform and a spring platform clamp:* Loosen the platform clamp screw. Turn the spring platform clamp as far up as needed to move the spring. Or, turn the spring by hand to the desired position.

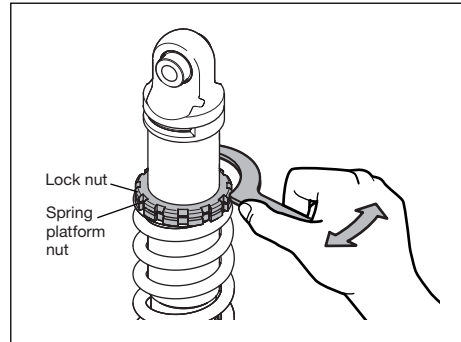

Loosen the platform clamp screw.

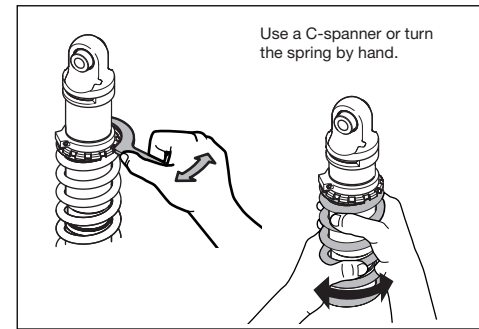
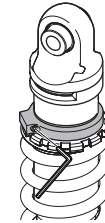

Adjustments

Rebound and Compression Damping

Rebound and Compression damping

If your motorcycle is equipped with rebound and compression damping, the damping is set with knobs and/or screws with a normal right-hand thread. By turning them clockwise the damping action increases and by turning them counter clockwise it will be reduced. Most of the adjusters have definite positions with a noticeable “click”, which makes it easy to count to the right setting.

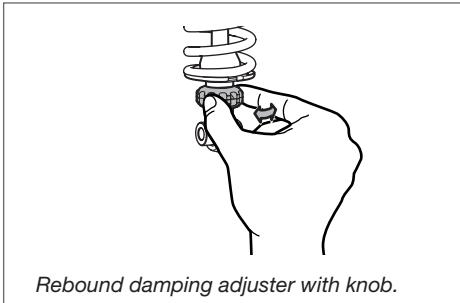

Rebound damping adjuster with knob.

NOTE!

If you cannot feel the “clicks” on the rebound knob, the shock absorber must be inspected by an authorized Öhlins service workshop. It could be due to low gas pressure or lack of oil.

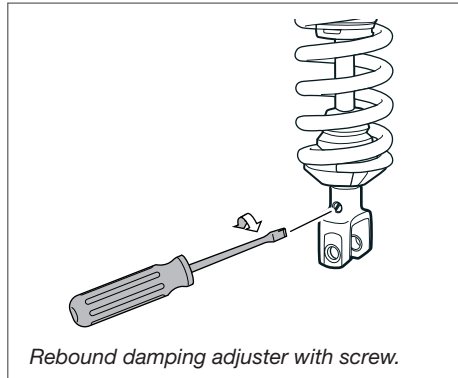

Rebound damping adjuster with screw.

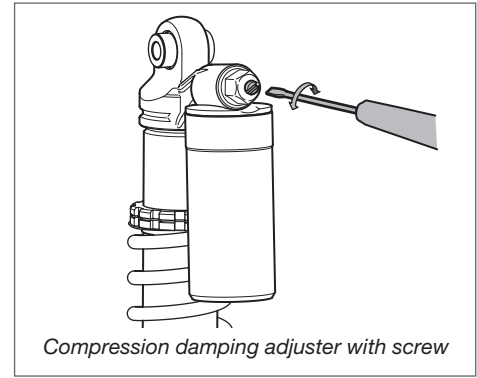

Compression damping adjuster with screw

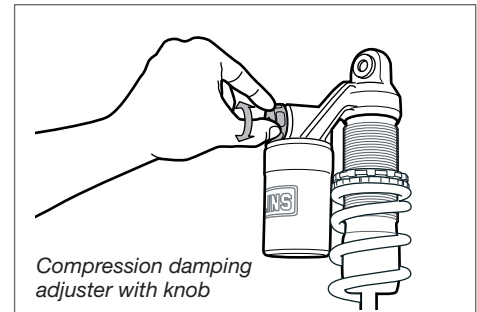

Compression damping adjuster with knob

Adjustments

High and Low Speed Compression Damping

High and Low speed

Some models (called PRX) have separate adjusters for high and low speed compression. The low speed compression is adjusted in 25 steps. The high speed adjuster has a wide range without steps.

The compression damping affects the energy absorption during compression and thus the force needed to compress the suspension. More compression damping will make the suspension firmer and make the vehicle run a little bit higher.

On PRX shock absorbers, the X stands for high and low speed compression adjuster.

- Low speed circuit: More damping will make the ride firmer and higher.
- High speed circuit: More damping gives a firmer ride and more resistance against bottoming.

The rebound damping affects the energy absorption during rebound and thus the force needed to extend the shock absorber. More rebound damping will make the extension slower, and vice versa. The external rebound adjustment actually also affects the compression damping by the ratio of approximately 90% rebound damping and 10% compression damping.

NOTE!

The damping forces are related to the speed between the shock absorber piston and the shock absorber body. The damping forces do not vary with the position of the piston inside the shock absorber.

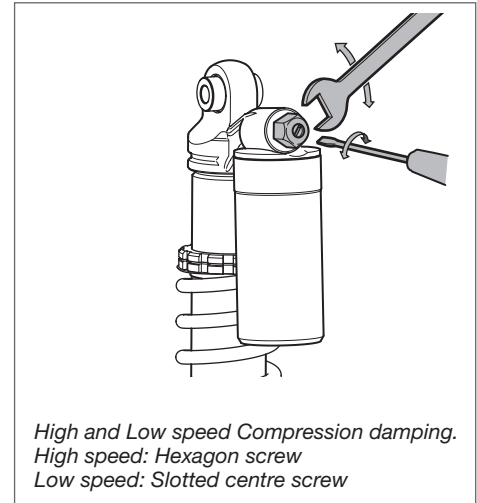

*High and Low speed Compression damping.
High speed: Hexagon screw
Low speed: Slotted centre screw*

Adjustments

Setting Ride Height and Free Sag

The spring preload is very important since it affects the height of the motorcycle and the front fork angle. Therefore, handling characteristics can be changed, even negatively.

Measure ride height and free sag:

- Put the motorcycle on a stand so that the front fork and the rear end are in fully extended position.
- Measure the distance from the lower edge of the rear mudguard or from another point marked by a piece of tape, immediately above the rear wheel axle, to the wheel axle (R1).
- Take a similar measurement on the front axle, for example from the bottom of the upper triple clamp to the front wheel axle (F1).
- Apply load on the springs and repeat the measuring procedure (R2, F2).
- Take the same measurements with the rider and equipment on the motorcycle (R3, F3). It is important that the rider has a correct riding posture, so that the weight is balanced on the front and the rear wheel in the same way as when riding.

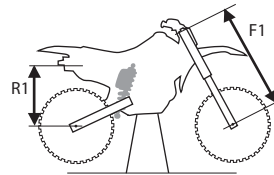

Motorcycle on a stand.

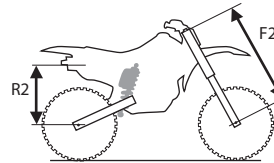

Motorcycle on the ground.

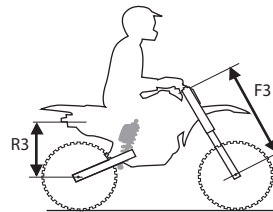

Motorcycle with rider on.

Recommended Ride Height and Free Sag

If no recommendations are given in the Mounting Instructions, use the following:

Free sag: (R1-R2), (F1-F2)

Rear: 30±5 mm

Front: 30±5 mm

Ride height: (R1-R3), (F1-F3)

Rear 100±5 mm

30% of the total stroke

Front 80±5 mm

Adjust the Spring Preload

If your measures differ from the recommendations in the Mounting Instructions or above, adjust the spring preload according to the section Adjustments - How to Set the Spring Preload in this manual.

▲ WARNING!

Incorrect spring action may produce a fork angle that is too steep or too flat. This in turn will give a tendency for over- or under steering, which could seriously affect the handling characteristics of the motorcycle.

Set Up Your Motorcycle

How to prepare the settings

With the adjustment possibilities explained earlier in this manual, you can test by trial and error, and learn how they affect your vehicle.

Start with a test ride with all adjustments at their basic setting. Choose a short run of varying character, for example long and sharp bends, hard and soft bumps. Keep to the same run and adjust only one setting at a time.

Recommended Adjustment Range

- *Rebound/ Low speed compression damping: ±5 clicks from original (basic) setting.*
- *High speed compression damping: ±1 turn from original (basic) setting.*

Start with Rebound Damping

If the motorcycle feels unstable, loose and rather bouncy - increase the rebound damping. Begin by turning the adjuster knob two steps (clicks). Test run again and adjust one step back if it felt too hard and bumpy.

If the motorcycle feels hard and bumpy, especially over a series of bumps - reduce the rebound damping. Turn two steps, test run and make the necessary adjustments. For original rebound setting see the Mounting Instructions for your shock absorber.

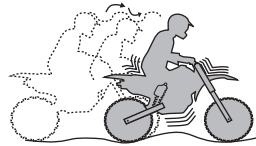

If the motorcycle feels

- unstable
- loose
- bouncy

...increase rebound damping



If the motorcycle

- feels soft
- feels low
- is bottoming

...increase compression damping



If the motorcycle feels

- hard
- bumpy

...decrease rebound damping



If the motorcycle feels

- harsh
- hard

...decrease compression damping

Compression Damping

If the motorcycle feels soft, has low riding position and a tendency to bottom easily in long dips - increase the compression damping.

If the motorcycle feels harsh and has hard resilience - reduce the compression damping.

If your shock absorber is equipped with high and low speed compression damping adjuster, adjust the high speed compression only.

Turn ¼ turn at a time. Test run and make necessary corrections. When you have sufficient feel of the motorcycle you can make further fine adjustments. It is feeling and experience that counts.

NOTE!

Make sure that the springs are properly preloaded before attempting to make any adjustments. A simple rule is that increased preload of the spring should be followed by an increase of rebound damping by two steps.

When you feel that you have achieved an improvement, go back to where you started and check once more. Note other relevant factors such as tires, temperature etc. Test run to make sure whether further fine adjustments should be made.

General Handling Set-up

Trouble Shooting

Front end falls into the corners (over-steering) especially in sand.

Steep front fork angle. Front end too low in comparison to rear end.

- Increase the front fork compression damping.
- Change to harder springs.
- Lower fork leg approximately 5 mm in the triple clamp.

Front end "ploughs", understeers.

Shallow front fork angle. Front end too high in comparison to rear end.

- Decrease the front fork compression damping.
- Raise the fork legs approximately 5 mm in the triple clamp.
- Change to softer fork springs.

Front end unstable at high speed, unstable when accelerating out of curves.

Front fork angle too steep. Front end too low in comparison to rear end.

- Lower the fork legs approximately 5 mm in triple clamp.
- Change the front fork springs to hard er ones.

Front end unstable during deceleration.

Front fork angle too steep during braking.

Front end too low or rear end too high.

- Increase the oil level in the front fork.
- Change to harder fork springs.
- Increase the front fork compression damping.

Front suspension

Front fork travel is not used to its full capacity. Harsh feeling, front wheel grip is not satisfactory in bumpy turns.

Suspension too hard.

- Decrease the front fork compression damping.
- Change to softer springs.

Suspension bottoming, too soft during entire travel.

Spring too weak or compression damping too soft.

- Increase oil level 5 mm.
- Increase compression damping.
- Change to stiffer springs.

Suspension bottoming, but can handle smaller bumps.

Damping force not progressive enough.

- Increase the oil level.

Can handle smaller bumps but is too hard during the last part of the travel.

Damping force is too progressive.

- Decrease the oil level.

Front end feels low, initially feels soft, but is not bottoming.

The initial spring rate is too soft or spring preload is too low.

- Increase the spring pre-load.

Feels harsh over small bumps, but using full wheel travel.

Too much spring pre-load or too much compression damping.

- Increase the oil level or change to softer springs.
- Decrease the compression damping.
- Decrease the spring pre-load.
- Clean the oil seals and scrapers. Use Öhlins red grease 00146-01.

General Handling Set-up

Trouble Shooting

Can handle the first in a series of bumps but feels hard after a few more bumps. Frontal grip insufficient in rough and bumpy turns.

Too much rebound damping.

- Decrease the rebound damping.

Front end rebound too fast after a bump. Front wheel grip insufficient in bumpy curves.

Not enough rebound damping, or too much spring pre-load

- Increase the rebound damping.
- Decrease the spring pre-load.

Rear suspension

Rear suspension stroke is not used to its full capacity. Suspension feels harsh. Traction not satisfactory in bumpy curves.

Suspension hard in general or too much compression damping, too much spring pre-load.

- Decrease the compression damping.
- Decrease the rebound damping.
- Change to softer spring.

Suspension is bottoming, feels soft during the entire wheel travel.

Spring too soft, compression damping too low.

- Increase the compression damping.
- Change to harder spring.

Suspension is bottoming, feels harsh and sags down too much with the rider in the saddle.

Spring too soft or compression damping too low.

- Increase the spring pre-load, check ride height: 95 ± 5 mm.
- Change to harder spring if the load is more than 100 mm.
- Increase compression damping.

Rear wheel jumps over small bumps during deceleration or when going downhill. Traction not satisfactory in washboard curves.

Too much spring pre-load, as the spring is probably too soft, will cause the spring to extend too fast.

- Change to a harder spring in order to achieve a balanced position using less spring preload.
- Check the static sag and ride height.

Rear end kicks up over bumps with sharp

edges, but can handle bumps with round edges.

Compression damping too hard.

- Decrease the compression damping.

Rear end becomes too low in series of bumps. Traction not satisfactory in washboard type curves or when decelerating on washboard ground.

Rebound damping too slow.

- Decrease the rebound damping.

Rear end very unstable. Shock absorber does not respond to adjustments.

Shock absorber damping is gone, caused by low gas pressure, bad oil is used, or components are broken in the shock absorber. Service is needed.

- Gas filling required.
- Change shock oil.
- Repair the shock absorber.

NOTE!

Recommended measures are not listed in order of importance. One of the listed measures can be sufficient to solve a particular handling problem.

Inspection and Maintenance

What and How Often?

Preventive maintenance and regular inspection reduces the risk of functional disturbance. If there is any need for additional service, please contact an authorized Öhlins workshop.

Cleaning

Clean the shock absorber externally with a soft detergent. Use compressed air. Be careful that all ice water, dirt and debris is removed. Lift the bump rubber and clean the area below from ice and dirt. Keep the shock absorber clean and always spray it with oil (QS 14, WD40 or CRC 5-56) after washing.

Lift the bump rubber and clean the area below.

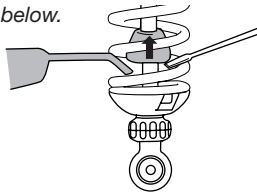

NOTE!

The Öhlins shock absorber should only be filled with the Öhlins High Performance Shock Absorber Oil.

Inspection

1. Check ball joints for possible excessive play or stiction.
2. Check the piston shaft for leakage and damage.
3. Check the shock absorber body for external damage.
4. Check the external reservoir for damage that can restrict the floating piston from moving freely.
5. Check for excessive wear of rubber components.
6. Check the attachment of the shock absorber to the vehicle.
7. Check the hose equipped models for leaks in the hose and inlet plugs.

Recommended Service intervals

MX/ Enduro: Every 20 hours of operation

Off-Road: 2-3 times/ year

⚠ WARNING!

Never alter the gas pressure. Special purpose charging equipment and access to nitrogen is required.

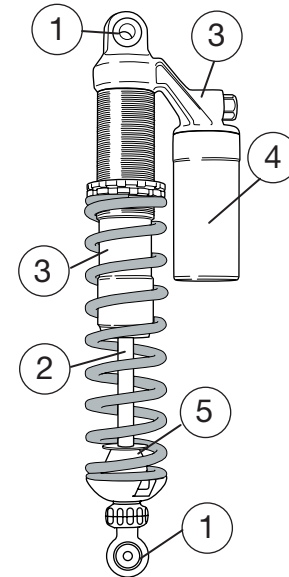

Disposal

Discarded Öhlins products should be handed over to an authorized Öhlins workshop or distributor for proper disposal.

www.ohlins.com

Owner's Manual 07251-02 Issued 2006 11 17
Öhlins Racing AB, Tiina Harakka Carlsson