

**Note!**

Please note that this image is a general representation of the product and may differ slightly from your product.

**Note!**

Please note that during storage and transportation, especially at high ambient temperature, some of the oil and grease used for assembling may leak and stain the packaging. This is in no way detrimental to the product, wipe off the excessive oil/grease with a cloth.

**Note!**

Before installing this product, check the contents of the kit. If anything is missing, please check an Öhlins dealer.

**Kit Contents**

Description	Part No	Pcs
Shock absorber	HO 831	1
Tool preload adjuster	03199-03	1
Washer	63118-05	2
Screw M8x35	00432-01	1
Sticker set "ÖHLINS"	10207-01	1
Owners manual road & track	07241-02	1

**Note!**

THE MOTORCYCLE REAR MUDGUARD NEEDS TO BE EXCHANGED OR MODIFIED TO FIT TO THE ÖHLINS SHOCK ABSORBER

**Warning!**

Before installing this product, read the Öhlins Owner's Manual. The shock absorber is an important part of your vehicle and will affect the stability.

## Shock Absorber for Honda Click150i-2018

# HO 831

## Mounting Instructions

# MOUNTING INSTRUCTIONS

## **⚠ Warning!**

*It is advisable to have an Öhlins dealer install the shock absorber.*

## **⚠ Warning!**

*If working on a raised vehicle, ensure it is securely supported so that it will not tip over.*

## **👁 Note!**

*Before mounting this product clean the vehicle thoroughly.*

## **👁 Note!**

*When working on this product, always see the Vehicle Service Manual for vehicle specific procedures and important data.*

1

Put the motorcycle on a work stand so that the rear wheel barely touches the ground. Make sure the motorcycle is in a stable position.

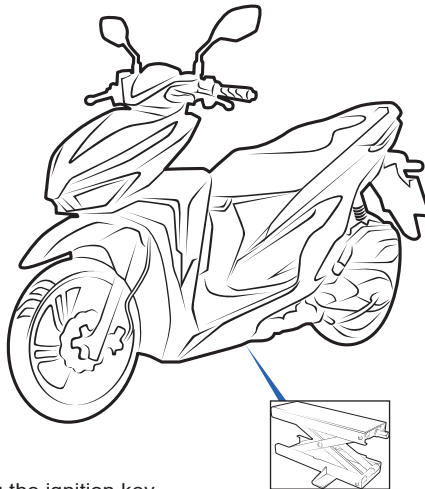

2

Open the seat by using the ignition key.

2.1

Loosen the screws ① ② on both sides of the motorcycle in order to remove the plastic cover Ⓐ.

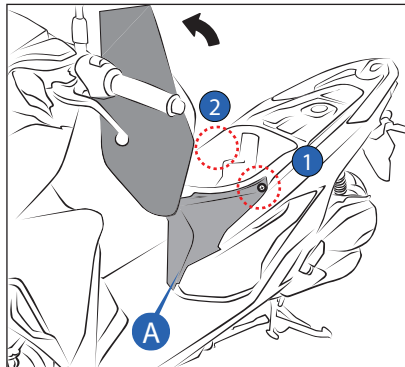

# MOUNTING INSTRUCTIONS

3

Remove the grab bar **B** by loosening the screws **1** **2** **3**.

3.1

Remove the fuel cover **C** by loosening the screws **4** **5** **6** **7**.

3.2

Loosen the screws **8** **9** **10** and lift up the storage box **D**.

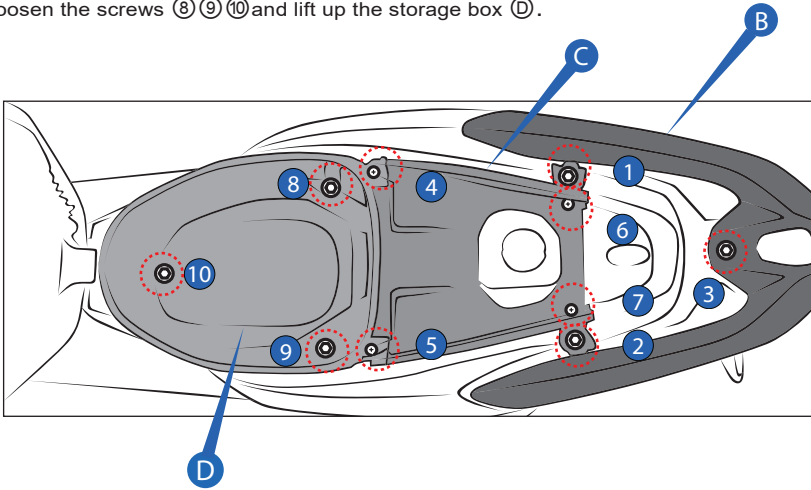

4

Remove the plastic push-clip **E** and unlock the wiring **F** in order to remove the storage box **D**.

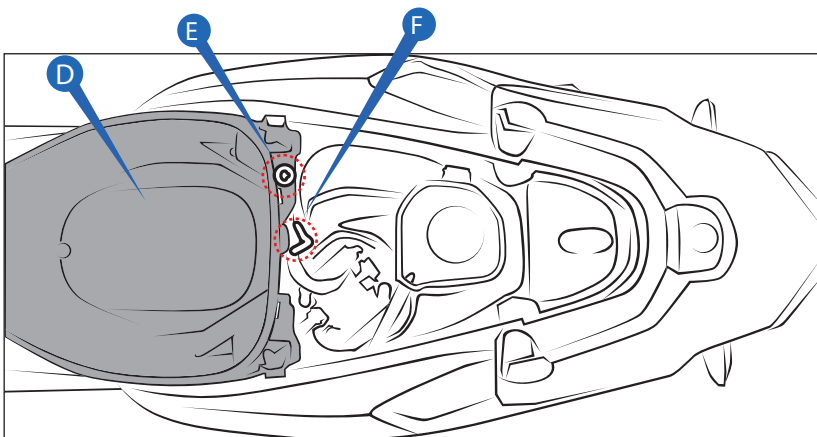

# MOUNTING INSTRUCTIONS

5

Loosen the screws ①②③④.

5.1

Loosen the screws ⑤⑥ and the plastic push-clips ⑦ located underneath the cover ③.

The screws ⑤⑥ and the plastic push-clips ⑦ are located on both side of the motorcycle.

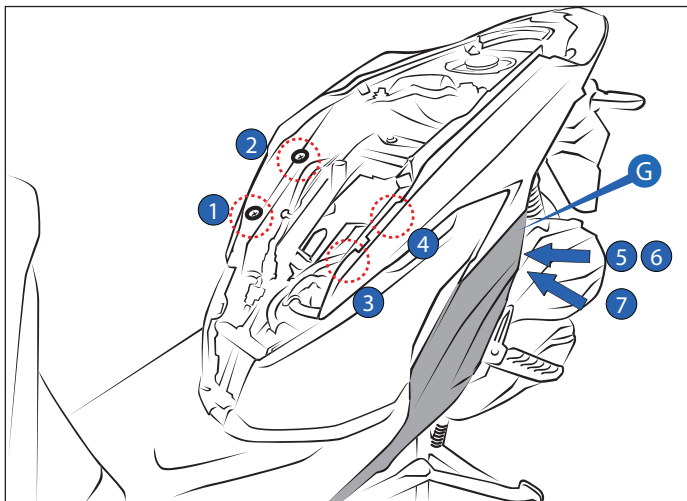

6

Loosen the screws ①②③④⑤ to remove the cover ⑥ located under the rear lamp.

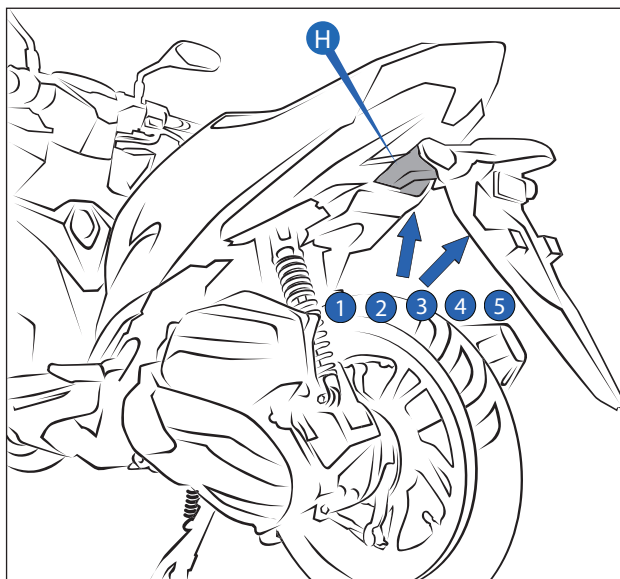

# MOUNTING INSTRUCTIONS

7

Loosen the screws ① ② ③ to remove the rear fender ④.

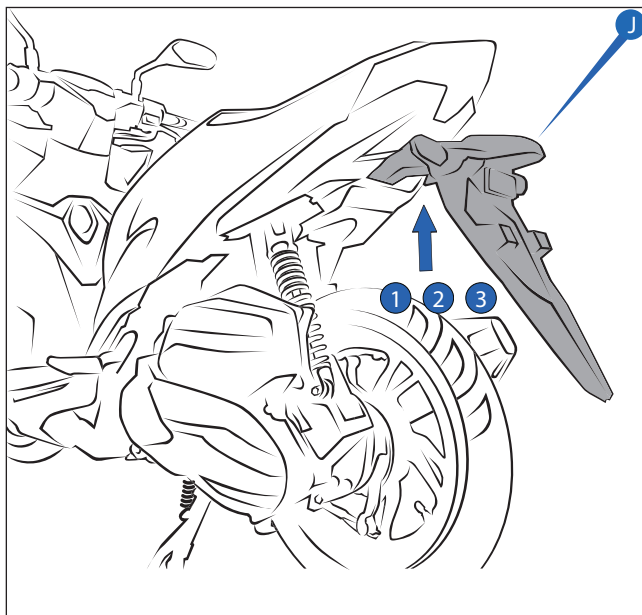

## 👁 **Note!**

*The side fairing (K M) and the tail light (L) will be removed all together*

8

Remove the side fairings (K M) and tail light (L) all together by sliding it towards the rear of the motorcycle.

8.1

Unplug the electrical connector (N).

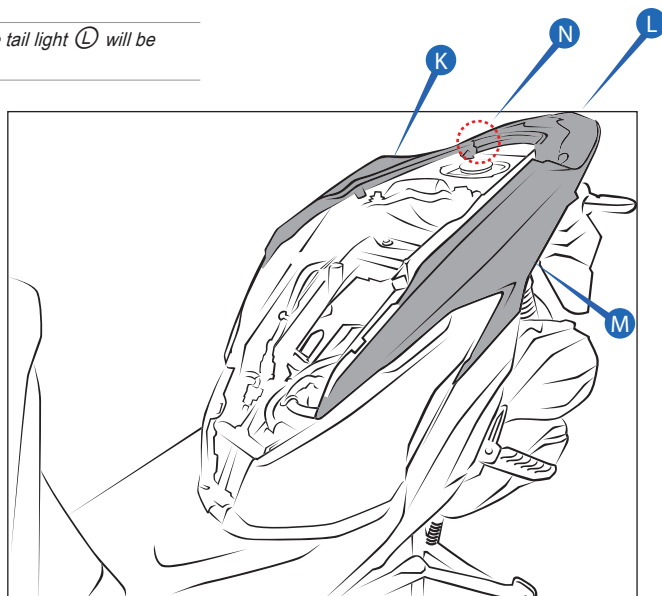

# MOUNTING INSTRUCTIONS

9

Loosen the screws ①② to slide down the rear mudguard ③ for providing access to the shock absorber top mounting screws.

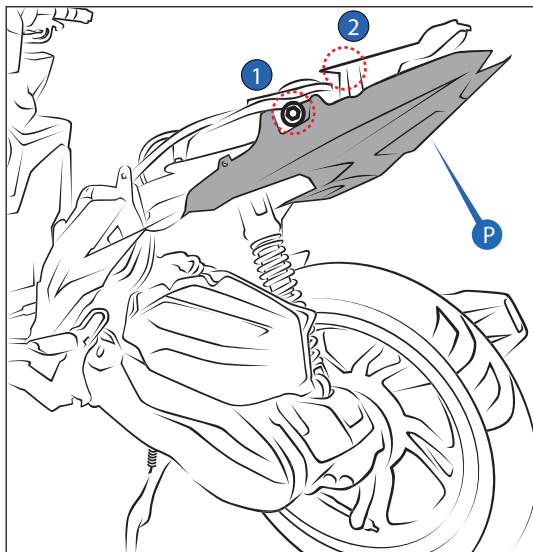

10

Remove the standard shock absorber by loosening the upper and lower mounting bolts ①② and remove the rear mudguard ③.

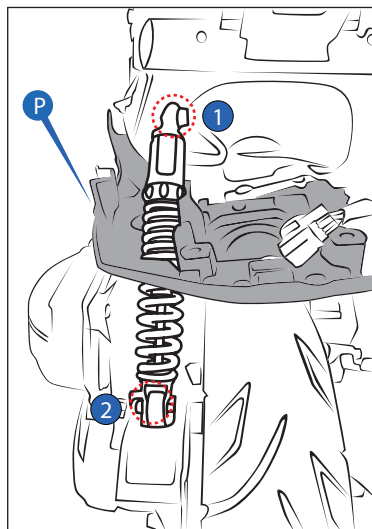

# MOUNTING INSTRUCTIONS

11

See appendix 1 for rear mudguard modification on page 8.

11.1

Reinstall for the rear mudguard and the Öhlins shock absorber by tightening the upper mounting bolts ① ② at a torque value as specified in the vehicle service manual and reverse all procedure as necessary.

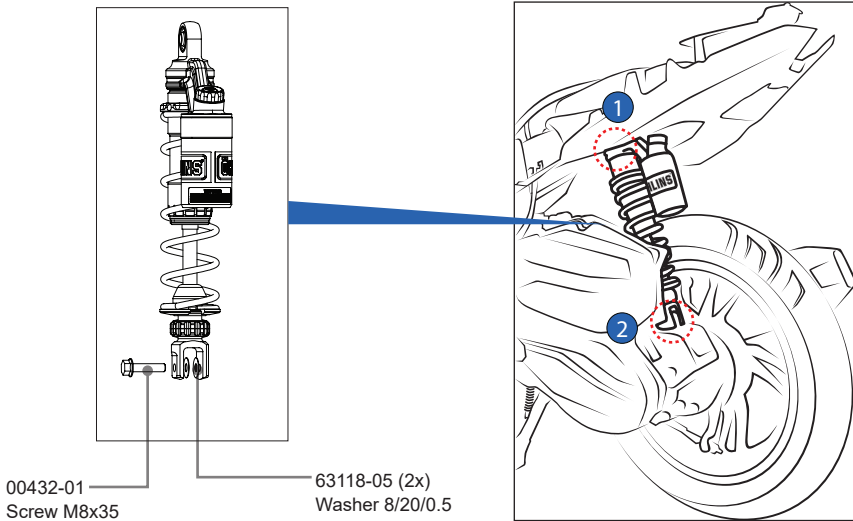

## **Note!**

*Lower the vehicle so that the suspension is slightly compressed before tightening the screws.*

## **Caution!**

*Ensure that all screws are tightened to the correct torque and that nothing fouls or restricts movement of the shock absorber when the suspension is fully compressed or extended.*

# MOUNTING INSTRUCTIONS

## APPENDIX 1

- 1  
Cut the cutting template on page 9 .
- 2  
Apply glue to the back side of cutting template.
- 3  
Place the cutting template as per picture below
- 4  
Use a suitable tool to cut the material under the wording "Cutting Area".

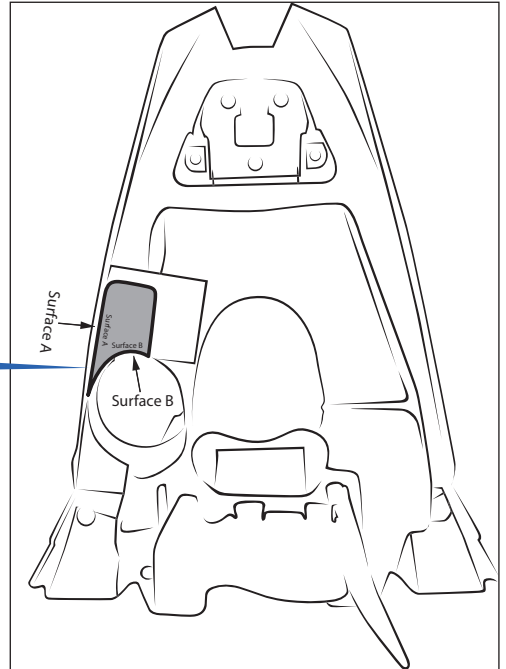
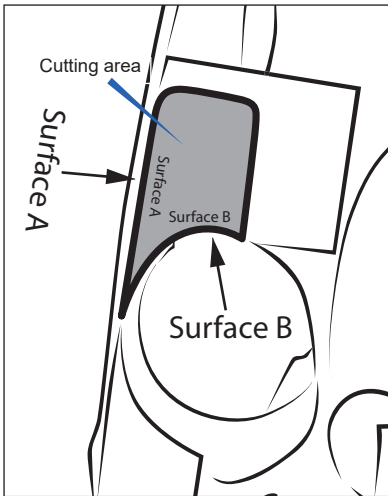



# MOUNTING INSTRUCTIONS

## CUTTING TEMPLATE

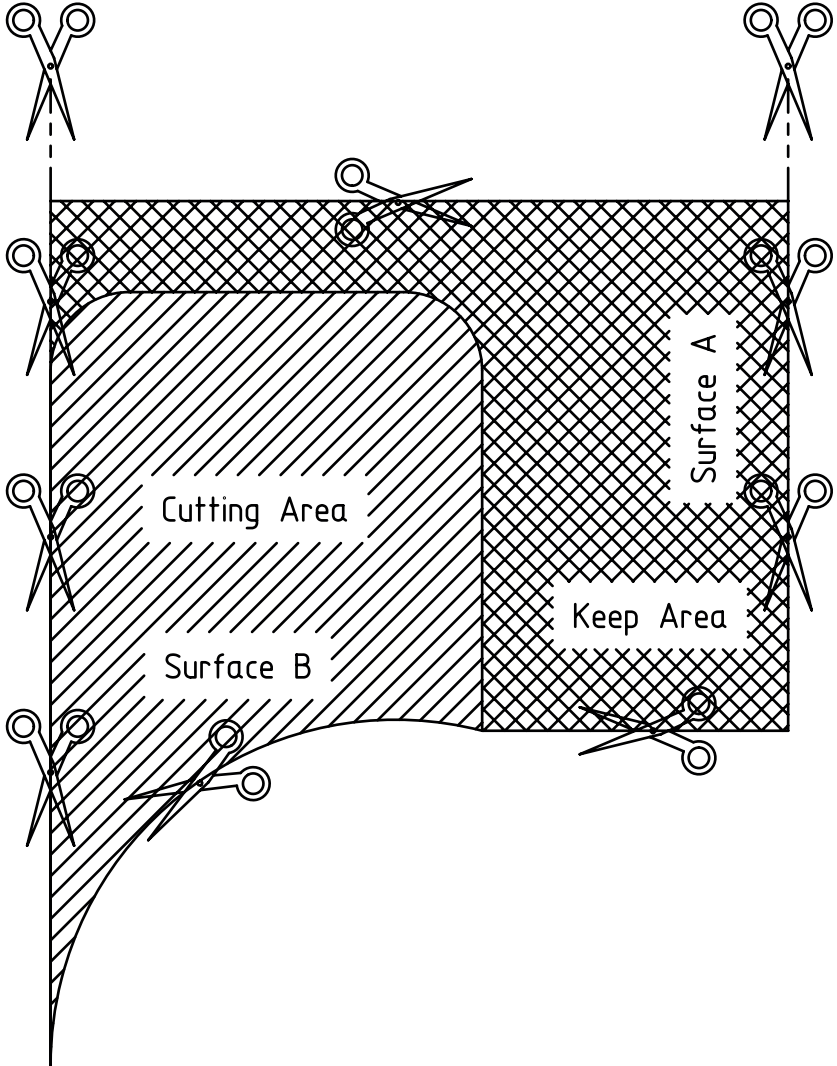

APPLY GLUE HERE AFTER  
CUT THE TEMPLATE

This page intentionally left blank

# ADJUSTMENTS

## **⚠ Warning!**

Before riding, always make sure that the basic settings made by Öhlins are according to recommended Set-up Data. Read about adjustments and setting up in the Öhlins Owner's Manual before you make any adjustments. Contact an Öhlins dealer if you have any questions about setting up.

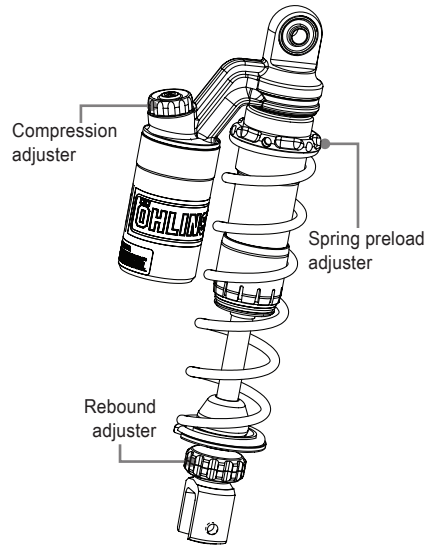

# SET-UP DATA

## **Recommended set-up**

Spring Preload.....	3 mm.
Compression adjuster.....	16 Clicks
Rebound adjuster .....	14 Clicks

<b>Spring data</b>	<b>Installed Spring</b>
Part No	60360-08
Free spring length	200 mm.
Spring rate	Prog. 31-35 N/mm
Preload adj.range	[0-18] mm.
For rider's weight	Below 80 kg

## **Shock absorber data**

Length .....	333 mm.
Stroke .....	85 mm.

👁 Öhlins products are subject to continuous improvement and development, therefore, although these instructions include the most up-to-date information available at the time of printing, minor updates may occur.

To find the latest information contact an Öhlins distributor. Please contact Öhlins if you have any questions regarding the contents in this document.

Part no. MI\_HO 831EN\_0  
Issued 2018-09-18

© Öhlins Asia Co. Ltd. All rights reserved. Any reprinting or unauthorized use without the written permission of Öhlins Racing AB is prohibited.

Öhlins Asia Co. Ltd  
700/937 Moo5, Tambol Nongkhaga,  
Amphur Phantong, Chonburi Province  
20160 Thailand



[www.ohlins.com](http://www.ohlins.com)