

👁 Note!

Please note that this image is a general representation of the product and may differ slightly from your product.

👁 Note!

Please note that during storage and transportation, especially at high ambient temperature, some of the oil and grease used for assembling may leak and stain the packaging. This is in no way detrimental to the product, wipe off the excessive oil/grease with a cloth.

👁 Note!

Before installing this product, check the contents of the kit. If anything is missing, please contact an Öhlins dealer.

Kit Contents

Description	Part No	Pcs
Shock absorber	HO 705	1
Sticker Öhlins	00192-01	2
C-spanner	00710-02	1
Owner's manual	07241-02	1

⚠ Warning!

Before installing this product, read the Öhlins Owner's Manual. The shock absorber is an important part of your vehicle and will affect the stability.

Shock Absorber for Honda CB 500X

HO 705

Mounting Instructions



MOUNTING INSTRUCTIONS

⚠ Warning!

It is advisable to have an Öhlins dealer install the shock absorber.

⚠ Warning!

If working on a raised vehicle, ensure it is securely supported so that it will not tip over.

👁 Note!

Before mounting this product clean the vehicle thoroughly.

👁 Note!

When working on this product, always see the Vehicle Service Manual for vehicle specific procedures and important data.

1

Place the motorcycle on a center stand, so that the rear shock can be safely removed.

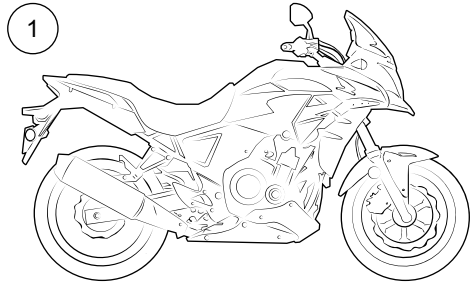

2

Open the seat and remove it.

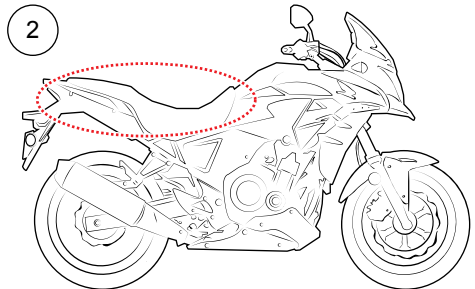

MOUNTING INSTRUCTIONS

- 3**
Remove the center cover on both sides by loosening the two bolts.

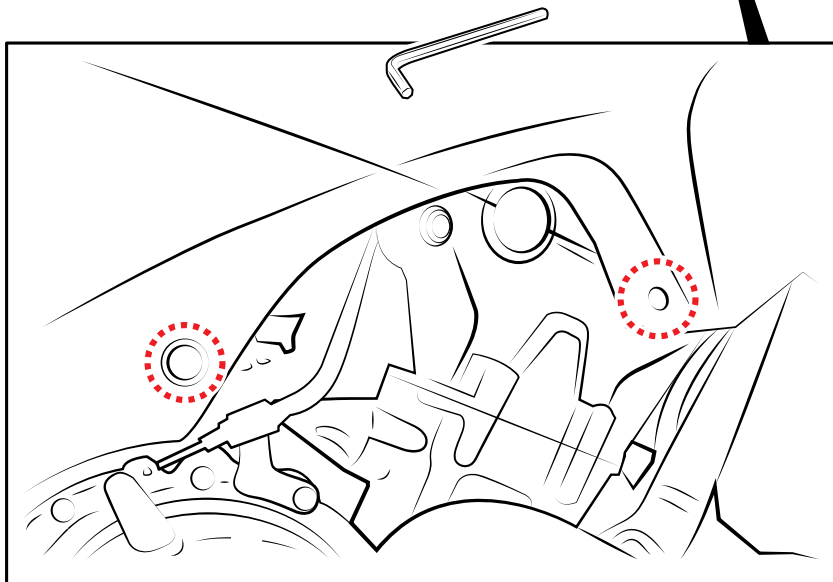
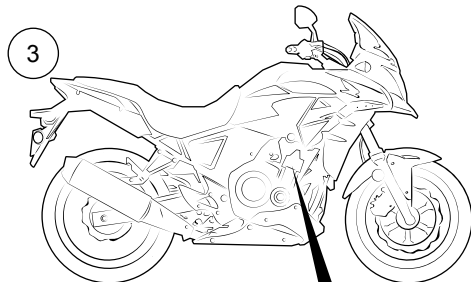

MOUNTING INSTRUCTIONS

4

Release the regulator by loosening the two bolts.

4

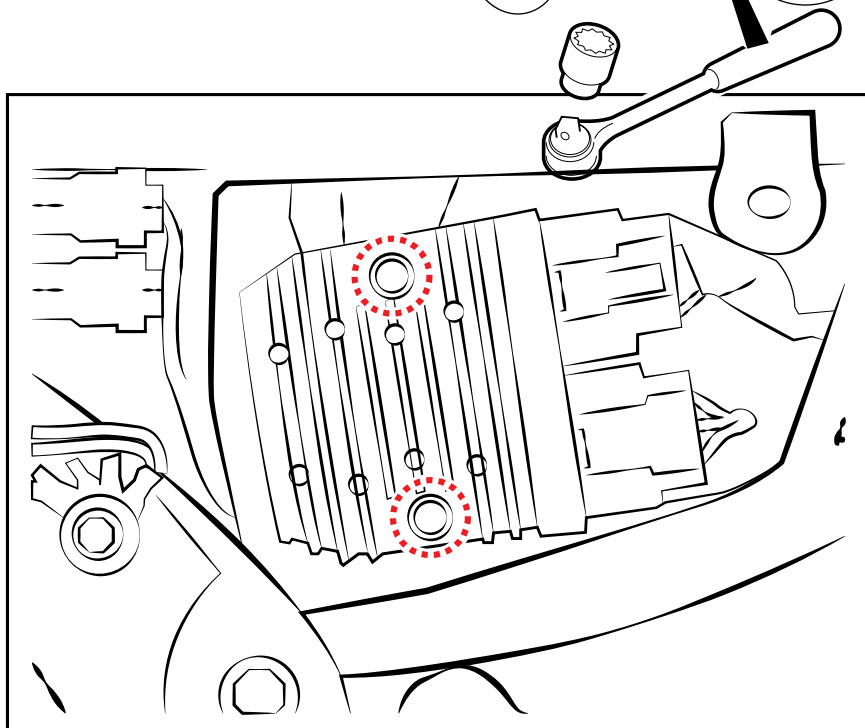
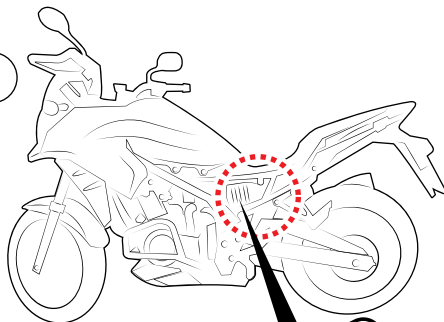

MOUNTING INSTRUCTIONS

5

Release the link by loosening the bolt (1) then remove original shock by loosening the two bolts upper (2) and lower (3) of shock.

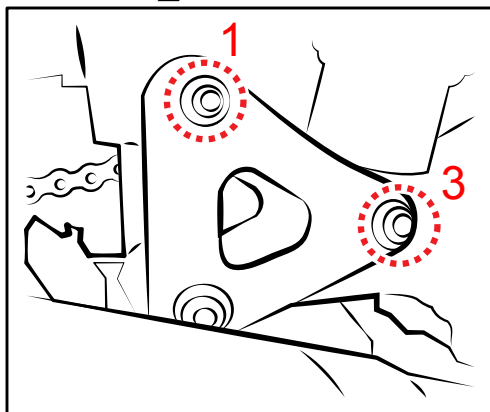
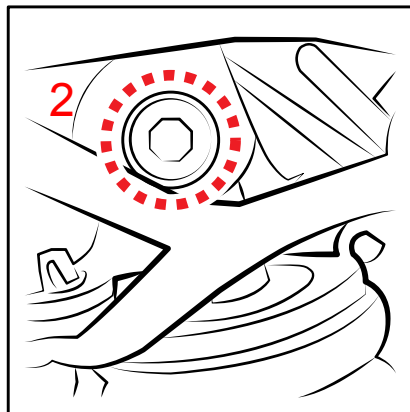
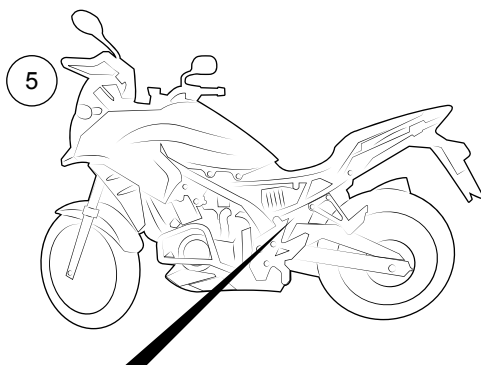

MOUNTING INSTRUCTIONS

6

Install the Ohlins shock with the shock body downward and the text readable from the rear of the vehicle. The rebound adjuster should be located on left hand side of the vehicle. Reverse the procedure to assembly the vehicle.

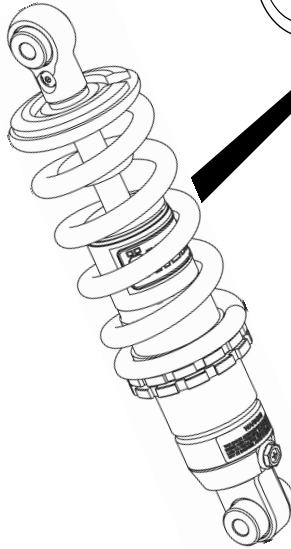
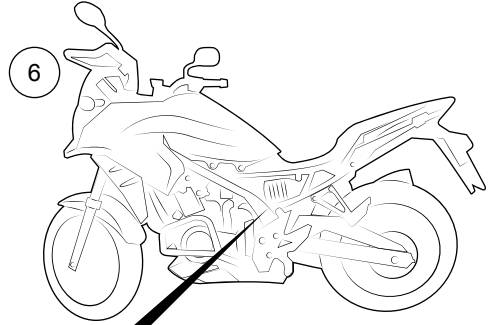

👁 Note!

Lower the vehicle so that the suspension is slightly compressed before tightening the screws.

👋 Caution!

Ensure that all screws are tightened to the correct torque and that nothing fouls or restricts movement of the shock absorber when the suspension is fully compressed or extended.

MOUNTING INSTRUCTIONS

ADJUSTMENTS

⚠ Warning!

Before riding, always make sure that the basic settings made by Öhlins are according to recommended Set-up Data. Read about adjustments and setting up in the Öhlins Owner's Manual before you make any adjustments. Contact an Öhlins dealer if you have any questions about setting up.

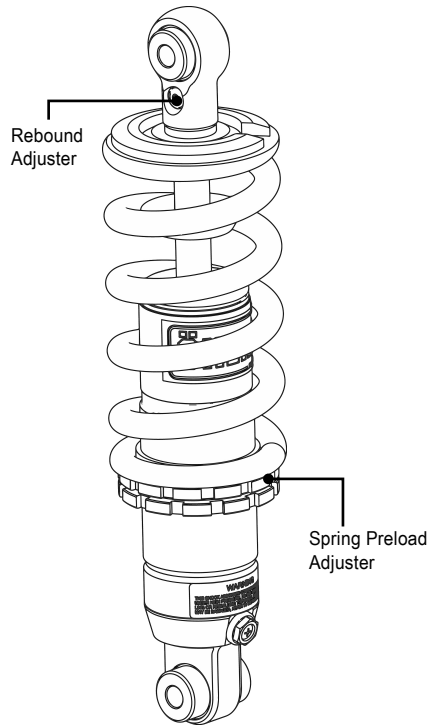

SET-UP DATA

Recommended set-up

Spring Preload 10 mm
Rebound Adjuster 14 clicks

Shock absorber data

Length 307 mm
Stroke 63 mm

Spring

Part No 61093-39
Free spring length 150 mm

👁 Öhlins products are subject to continuous improvement and development, therefore, although these instructions include the most up-to-date information available at the time of printing, minor updates may occur.

To find the latest information contact an Öhlins distributor. Please contact Öhlins if you have any questions regarding the contents in this document.

Part no. MI_HO 705_EN 0
2018-02-05

© Öhlins Asia Co. Ltd. All rights reserved. Any reprinting or unauthorized use without the written permission of Öhlins Racing AB is prohibited.

Öhlins Asia Co. Ltd
700/937 Moo5, Tambol Nongkhaga,
Amphur Phantong, Chonburi Province
20160 Thailand



www.ohlins.com