

*Before installing this product, check the contents of the kit. If anything is missing, please contact an Öhlins dealer.*

#### **Kit Contents**

	Part No.	Pcs.
Front fork kit	FGK224	1
Plug	21652-03	2
O-ring	00438-23	2
Öhlins Sticker (60x23) white	00191-32	2
Öhlins Sticker (60x23) blue	00191-33	2
Owners manual	07284-01	1

#### **⚠ Warning!**

*This kit should only be installed by an authorized Öhlins dealer. The installation procedure requires certain tools.*

*Please note that during storage and transportation, especially at high ambient temperature, some of the oil and grease used for assembling may leak and stain the packaging. This is in no way detrimental to the product, wipe off the excessive oil/grease with a cloth.*

#### **⚠ Warning!**

*Before installing this product, please read this document. The front fork is an important part of your vehicle and will affect the stability.*

#### **👁 Note!**

*Please note that after this installation the compression adjuster at the fork bottom will no longer have any function.*

## **Front Fork Kit for Ducati 1199 Panigale**

# **FGK 224**

### **Mounting Instructions**

# Safety Precautions

## 👁️ **Note!**

*The front fork is a very important part of the vehicle and will therefore affect the stability.*

👁️ *Read and make sure that you understand the information in this manual before you use this product. If you have any questions regarding installation or maintenance please contact your nearest Öhlins dealer.*

👁️ *Öhlins Racing AB can not be held responsible for any damage to the front fork, vehicle, other property or injury to persons, if the instructions for installing and maintenance are not followed exactly.*

## ⚠️ **Warning!**

*This product was developed and designed exclusively for a specific vehicle model and should only be installed on the intended vehicle model in its original condition as delivered from the vehicle manufacturer.*

⚠️ *After installing this product, take a test ride at low speed to make sure that your vehicle has maintained its stability.*

## 👁️ **Note!**

*When working on this product, always consult your Vehicle Service Manual.*

👁️ *This Manual should be considered as a part of the product and should therefore accompany the product throughout its life cycle.*

## Safety Symbols

In this manual, mounting instructions and other technical documents, important information concerning safety is distinguished by the following symbols:



*The Safety Alert Symbol means: Warning! Your safety is involved.*

## ⚠️ **Warning!**

*The Warning Symbol means: Failure to follow warning instructions can result in severe or fatal injury to anyone working with, inspecting or using the front fork, or to bystanders.*



## **Caution!**

*The Caution Symbol means: Special precautions must be taken to avoid damage to the front fork.*

## 👁️ **Note!**

*The Note Symbol indicates information that is important regarding procedures.*

© Öhlins Racing AB. All rights reserved. Any reprinting or unauthorized use without the written permission of Öhlins Racing AB is prohibited.

Printed in Sweden.

## Tools

Tool 00797-08



Tool 01765-03

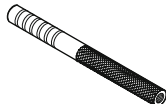

Tool 01797-07

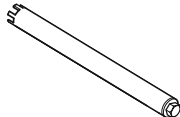

# 1 - Remove Original Front Fork

## ⚠ Warning!

It is advisable to have an Öhlins dealer install the front fork.

When installing, consult your Vehicle Service Manual.

### 1.1

Put the motorcycle on a workstand so that the front wheel barely touches the ground.

## ⚠ Warning!

Make sure the vehicle is securely supported so that it will not tip.

### 1.2

Remove the front fender, the brake calipers and the front wheel.

### 1.3

Release the spring preload.

### 1.4

Loosen the upper triple clamp by loosening the screws.

### 1.5

Loosen (do not remove) the top cap 1/2 turn.

### 1.6

Loosen the lower triple clamp by loosening the screws.

### 1.7

Remove the front fork legs from the triple clamps.

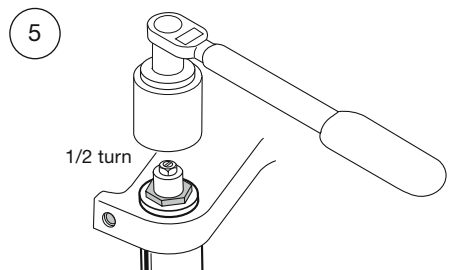
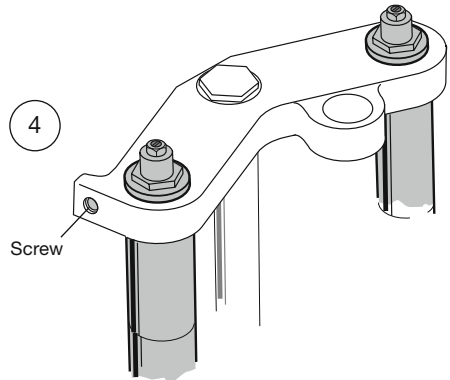
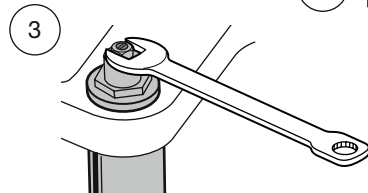
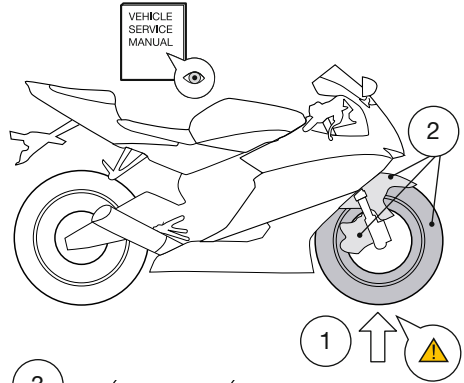

## 2 - Disassemble Original Front Fork

### 2.1

Loosen the top cap from the outer tube.

### 2.2

Pull down the outer tube.

### 2.3

Remove the top cap by loosening it from the shaft. Use appropriate tool according to your vehicle service manual.

### 2.4

Remove the spring and surrounding parts from the fork leg, remove the stop rubber from inside the outer tube.

### 2.5

Drain the fork leg from oil.

### 2.6

Remove the compression adjuster mounted in the fork bottom.

### 2.7

Loosen the cartridge. Use appropriate tool according to your vehicle service manual.

### 2.8

Remove the cartridge from the fork leg.

# 3 - Install Öhlins Front Fork Kit

## **Caution!**

Work with only one fork leg at a time. Do not mix the parts.

## **Caution!**

The front fork kit is divided into one compression cartridge and one rebound cartridge. Important:

- Install the cartridge marked "Reb" (Rebound) in the right side fork leg.
- Install the cartridge marked "Comp" (Compression) in the left side fork leg.

### 3.1

Remove the top cap.

### 3.2

Remove the spring support and preload tube.

### 3.3

Remove the cylinder tube from the cartridge.

## **Caution!**

Be careful not to damage the piston ring.

### 3.4

Put grease in the O-ring groove on the adaptor to hold the O-ring during mounting. Mount the O-ring in the groove.

### 3.5

Put the cylinder tube carefully into the fork leg. Note the guiding pin on the adapter to fit into the fork bottom. Use an extended 17 mm allen key to position the guiding pin into the guiding hole in the fork bottom by turning the whole cylinder tube.

## **Note!**

When mounting, make sure that the O-ring stays in place.

## **Warning!**

Make sure that the cylinder tube adaptor guiding pin fits into the guiding hole in the fork bottom.

### 3.6

Tighten the nut to the cylinder tube's adaptor using the extended 17 mm allen key and an appropriate tool at the bottom nut. Tightening torque and thread locking according to your vehicle service manual.

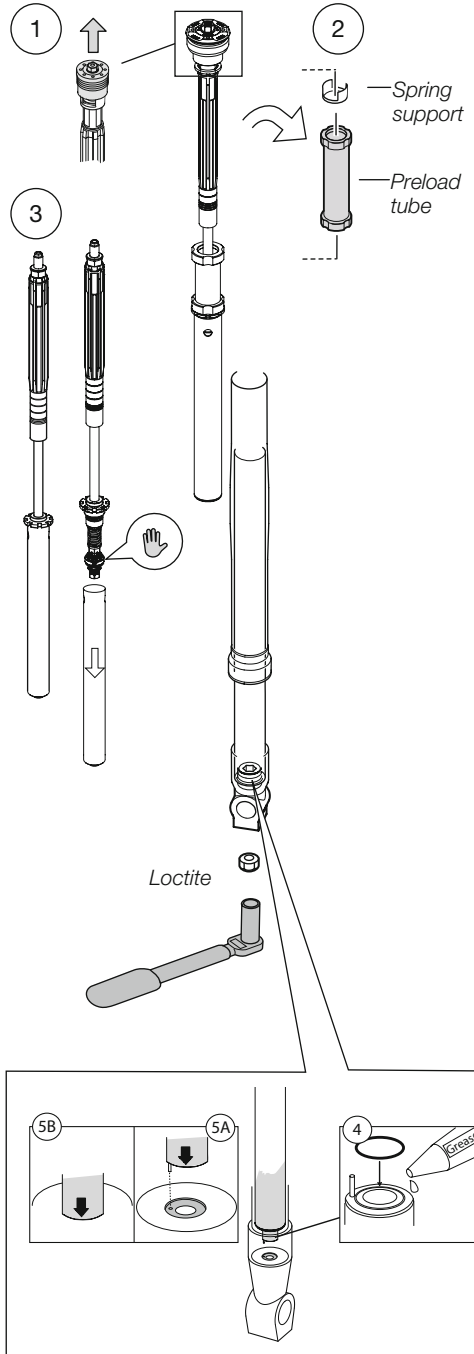

# 3 - Install Öhlins Front Fork Kit

## **Caution!**

*Be careful not to damage the inside of the cylinder tube when tightening with the extended allen key.*

### 3.7

Install the plug. Apply red grease on the O-ring. Use tightening torque 12 Nm.

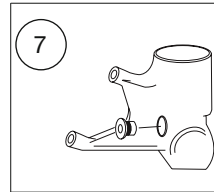

### 3.8

Pour 0,5 litre Öhlins Front Fork fluid into the fork leg.

### 3.9

Put the cartridge carefully in the fork leg. Tighten it to the cylinder tube. Use tool 01797-07. Apply red grease on the seal head's thread. Torque 20 Nm.

## **Caution!**

*Make sure that the piston ring is in its correct position and be careful not to damage it.*

### 3.10

Open the compression and the rebound adjuster fully. Install the top cap directly to the shaft extension (No spring or preload tube). Pull up the outer tube and tighten it to the top cap. Handtighten only.

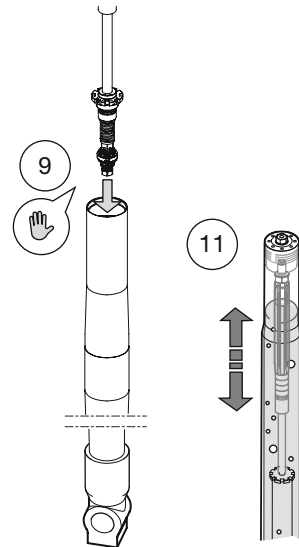

### 3.11

Pump out all air from the cartridge by pulling the outer tube up and down 10-15 times.

# Install Öhlins Front Fork Kit

## 3.12

Remove the top cap from the fork leg.

## 3.13

Make sure the shaft assembly is in the bottom of the fork leg and that the outer tube is in its bottom position. Measure the oil level with a ruler. See set-up data and oil level-force diagram in this folder.

## 3.14

Fasten tool 01765-03 on the top of the shaft extensioner, install preload tube, spring and upper spring support by leading them over the tool. See the Owner's Manual for available springs.

## 3.15

Pull up the shaft assembly and grab the spring support with a 19 mm wrench.

## 3.16

Make sure that the comp/rebound adjusters are fully open before installing the top cap. Remove the pull-up tool and install the top cap to the shaft extensioner. Torque 15 Nm.

## 3.17

Pull up the outer tube. Make sure the fork leg is in a fully extended position. Use tool 00797-08 to tighten the top cap to the outer tube. Torque 10 Nm.

## 3.18

Set the spring preload, rebound and compression adjusters according to adjustments and set-up data in this manual.

## 3.19

Install the front fork legs into the triple clamps at the position recommended in set-up data (Fork leg position). Tightening torque: According to your vehicle service manual.

### **Note!**

Measure the fork leg position from the upper triple clamp to the top of the outer tube.

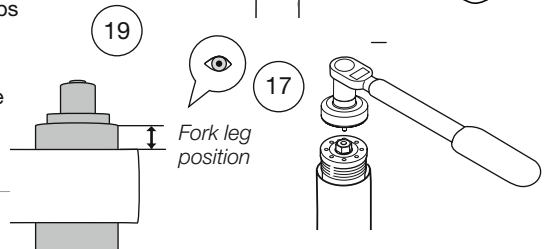
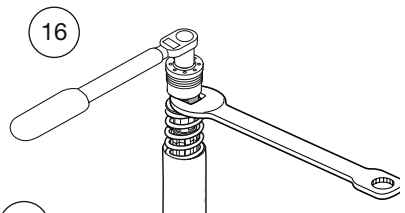
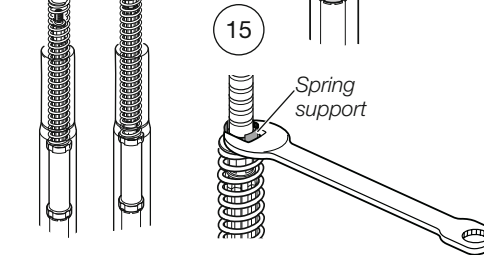
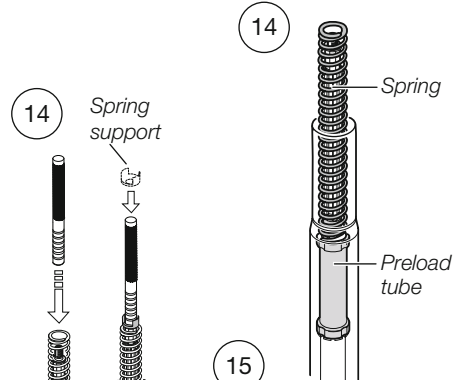
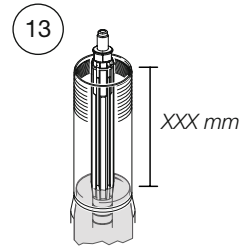

# Set-up Data

## Recommended set-up:

Compression	12 clicks
Rebound	12 clicks
Spring rate	10 N/mm
Spring preload	6 mm
Oil level	190 mm
Fork leg position	5 mm
Öhlins Front Fork Fluid part no	01309-01

## Diagram - Oil Level - Air Spring Force

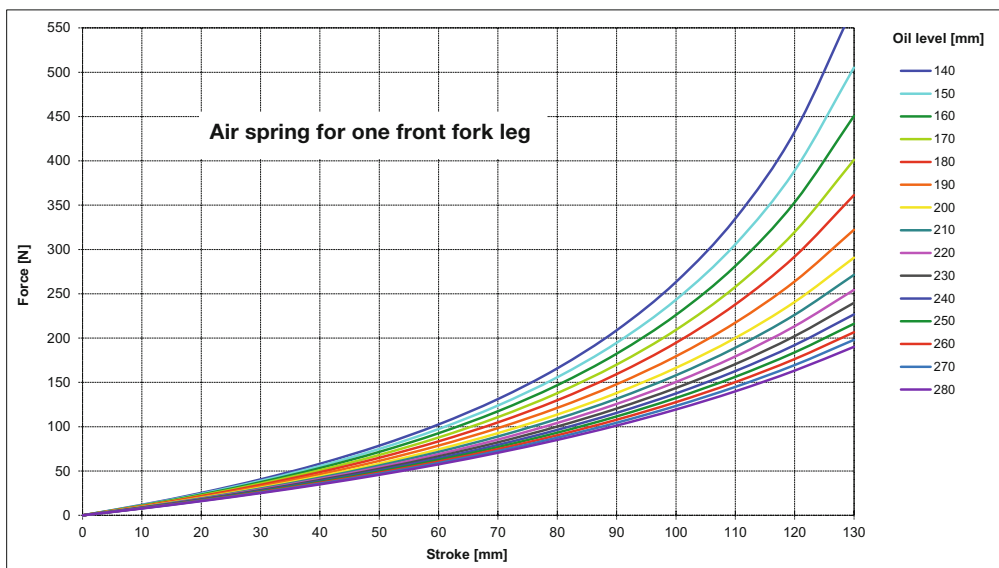

👁 Öhlins products are subject to continuous improvement and development, therefore, although these instructions include the most up-to-date information available at the time of printing, minor updates may occur.

To find the latest information contact your Öhlins distributor. Please consult your Öhlins dealer if you have any questions regarding the contents in this document.



Part no. FGK224\_1  
Issued 2012-10-24

© Öhlins Racing AB. All rights reserved. Any reprinting or unauthorized use without the written permission of Öhlins Racing AB is prohibited.

Öhlins Racing AB  
Box 722  
S-194 27 Upplands Väsby, Sweden  
Phone +46 8 590 025 00  
fax +46 8 590 025 80



[www.ohlins.com](http://www.ohlins.com)