

Kit Contents		
Description	Part No	Pcs
Main spring	08790-10	2
Preload tube	01460-70	2

⚠ Warning!

Only approved Öhlins personnel are permitted to install this kit. The procedure requires specific tools. This product is an important part of the vehicle and the vehicle stability.

👁 Note!

Before you install this product, check the kit contents. If anything is missing, please contact an Öhlins dealer.

⚠ Warning!

After you have installed the Öhlins product, take a test ride at low speed to ensure that the vehicle has maintained stability.

Spring kit normal height 10 N/mm for FK102

08866-01

Mounting Instructions

MOUNTING INSTRUCTIONS

Make sure you choose the correct spring for your rider weight, driving style and preferences. Contact an authorized Öhlins service center for advice.

⚠ Warning!

An incorrect spring rate can give a faulty front geometry leading to under or over steering and seriously affect the ground clearance and vehicle handling.

👁 Note!

Please note that there can be small differences between your product and the images in these instructions.

Install the spring and the spacer

The procedure requires specific tools and knowledge.

- Install the top out spring (A) in the fork leg.
- Install the cartridge (B), spring (C), preload tube (D) and top cap. Make sure to install all parts in the correct order.

To install together with a new FKC102 kit:

See the Mounting Instructions for FKC102.

To replace current main spring in already installed FKC102 kit:

See the Workshop Manual for Öhlins Front Fork Cartridge Kit FKC 100-series.

⚠ Warning!

The procedure requires specific tools and knowledge. If you have any questions contact an authorized Öhlins service center for advice.

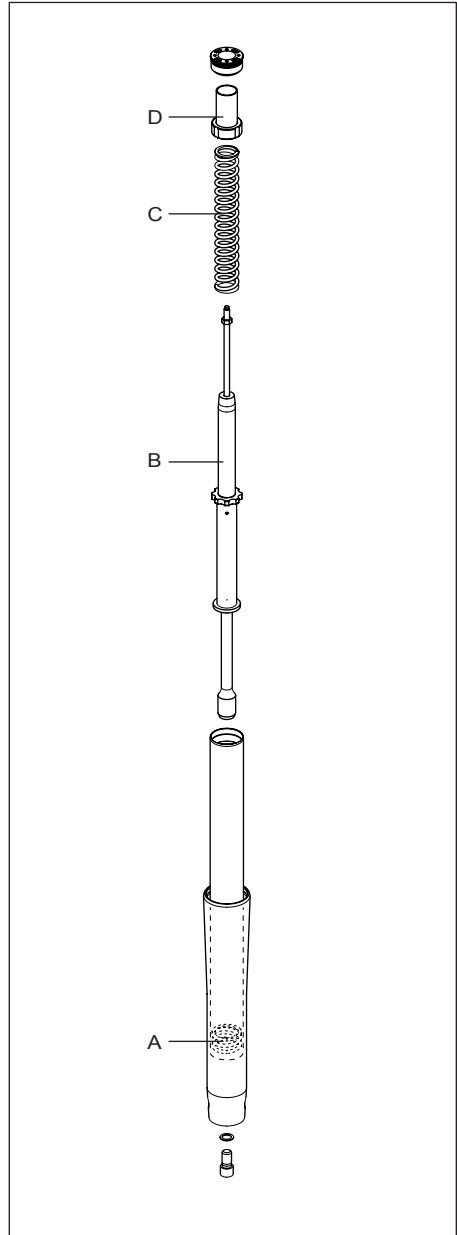

MOUNTING INSTRUCTIONS

This page intentionally left blank

SETUP DATA

Öhlins Front fork fluid	01309-xx	
Recommended oil level	80	mm

Öhlins products are subject to continuous improvement and development, therefore, although these instructions include the most up-to-date information available at the time of printing, minor updates may occur.

To find the latest information contact an Öhlins distributor. Please contact Öhlins if you have any questions regarding the contents in this document.

Part no. MI_08866-01_0
Issued 2015-01-08

© Öhlins Racing AB. All rights reserved. Any reprinting or unauthorized use without the written permission of Öhlins Racing AB is prohibited.

Öhlins Racing AB
Box 722
S-194 27 Upplands Väsby, Sweden
Phone +46 8 590 025 00
fax +46 8 590 025 80



www.ohlins.com