

### **Note!**

Before installing this product, check the contents of the kit. If anything is missing, please contact an Öhlins dealer.

### **Kit Contents**

Description	Part No	Pcs
Shock absorber LH	PI 902LH	1
Shock absorber RH	PI 902RH	1
Bracket	60130-03	1
Bracket	60130-04	1
Screw M10X60	64628-01	1
Screw M8x55	01046-27	2
Washer 10.5/20/2	60426-01	1
Nut M10	00430-01	1
Nut M8	00430-05	2
Washer 14/24/4	03118-03	2
Tool preload adjuster	03199-03	1
Sticker set "ÖHLINS"	10207-01	1
Owners manual	07241-02	1

### **Note!**

Please note that this image is a general representation of the product and may differ slightly from your product.

### **Note!**

Please note that during storage and transportation, especially at high ambient temperature, some of the oil and grease used for assembling may leak and stain the packaging. This is in no way detrimental to the product, wipe off the excessive oil/grease with a cloth.

### **Warning!**

Before installing this product, read the Öhlins Owner's Manual. The shock absorber is an important part of your vehicle and will affect the stability.

## Shock Absorber for Vespa GTS 300 ABS-Rear

# PI 902

## Mounting Instructions

# MOUNTING INSTRUCTIONS

## **⚠ Warning!**

*It is advisable to have an Öhlins dealer install the shock absorber.*

## **⚠ Warning!**

*If working on a raised vehicle, ensure it is securely supported so that it will not tip over.*

## **👁 Note!**

*When working on this product, always see the Vehicle Service Manual for vehicle specific procedures and important data.*

## **👋 Caution!**

*Make sure that all screws are tightened to the correct torque and that nothing fouls or restricts movement of the shock absorber when the suspension is fully compressed or extended.*

**1**

Put the motorcycle on a work stand so that the rear wheel barely touches the ground. Make sure the motorcycle is in a stable position.

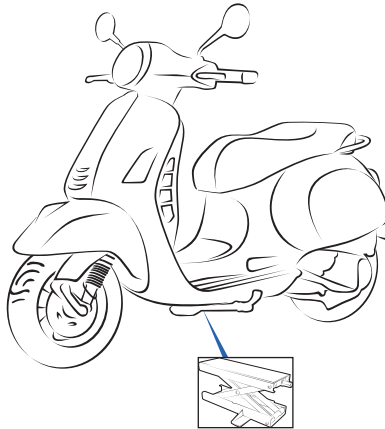

**2**

Open the seat. Loosen the screws ① ② ③ ④ and the fuel tank cap in order to remove the under-seat compartment.

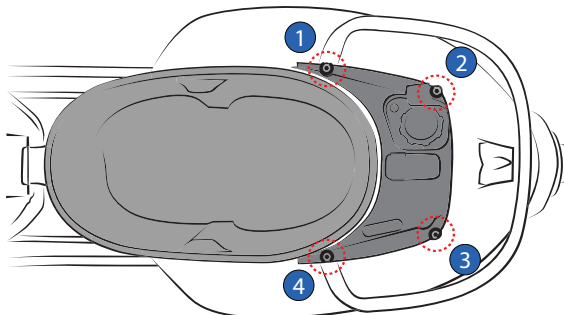

# MOUNTING INSTRUCTIONS

3

Reinstall the fuel tank cap (for your safety). Remove the shock absorber top mounting nut ①②.

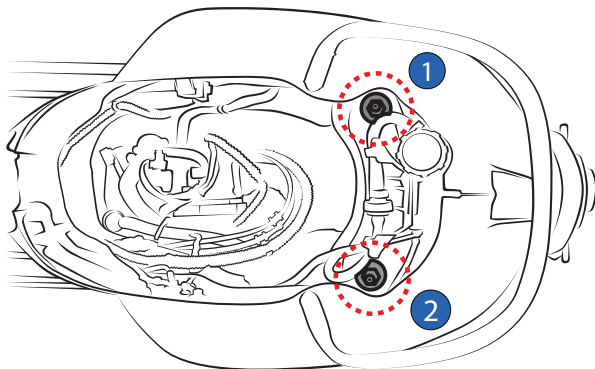

## **Note!**

*The laser marking on the cylinder heads identifies left (LH) and right (RH) side shock absorber.*

**ON THE LEFT SIDE:**

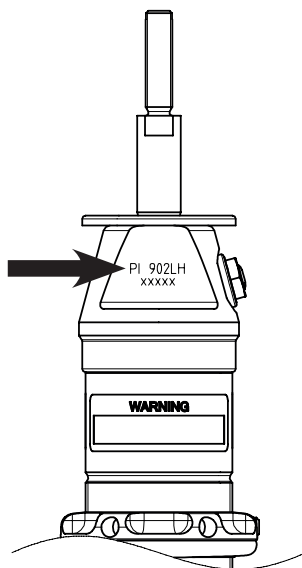

# MOUNTING INSTRUCTIONS

4

Dislocate the air box by loosening the 2 mounting screws ① ② in order to access the left shock absorber lower mounting point.

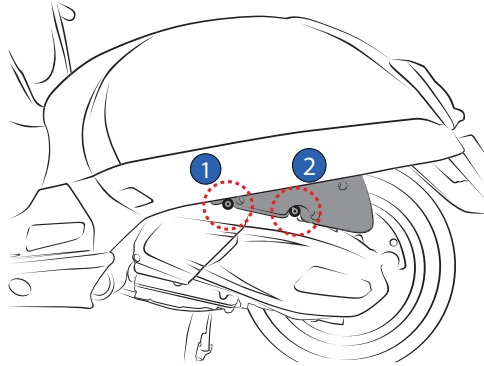

5

Remove the standard shock absorber by loosening the bracket mounting screws ① ② ③ as per diagram 1.

**Diagram 1**

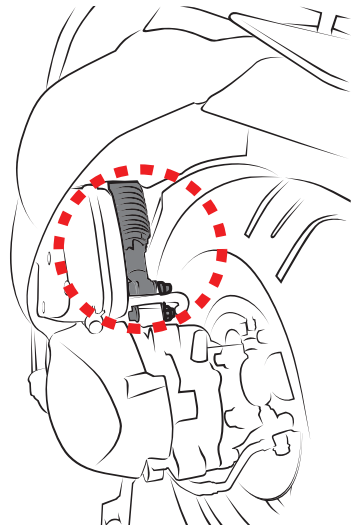
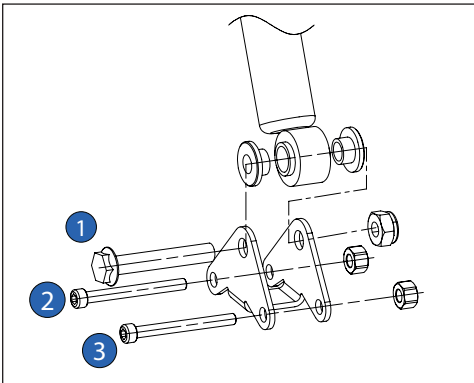

# MOUNTING INSTRUCTIONS

6

Prior assembling the Öhlins shock absorber on the motorcycle, install :

- The OEM nut on the top stud.
- The Lower OEM bushing on the top stud.
- The 2 OEM spacers on the lower end eye.

**Diagram 2**

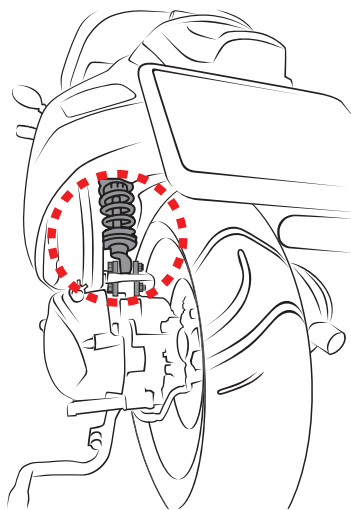
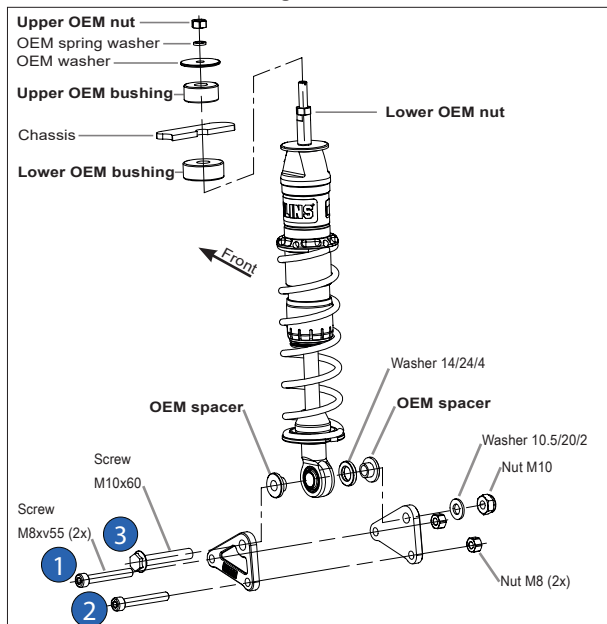

Tighten the screw ① ② ③ and upper OEM nut at a torque value as per Vespa service manual instructions.

# MOUNTING INSTRUCTIONS

7

**ON THE RIGHT SIDE :**

Remove the exhaust muffler by loosening the screws ① ② ③ ④

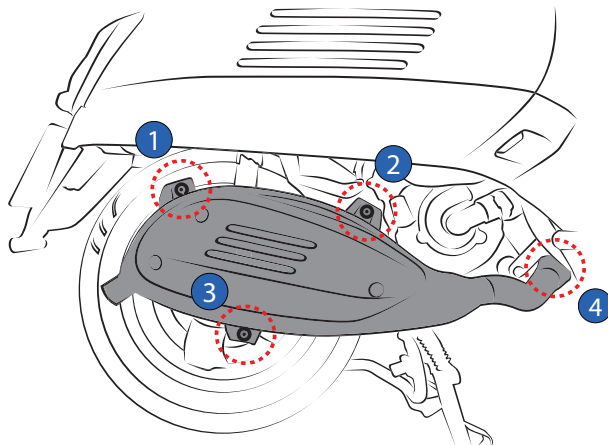

8

Remove the standard shock absorber by loosening the lower mounting nut ① as per diagram 3.

**Diagram 3**

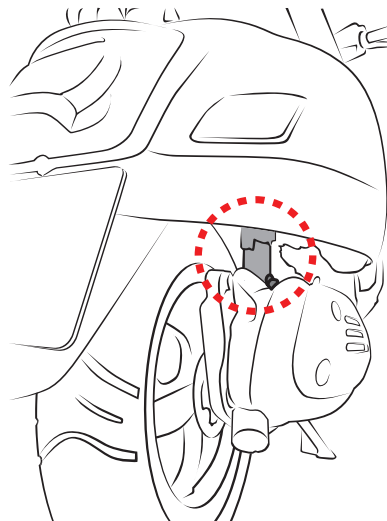
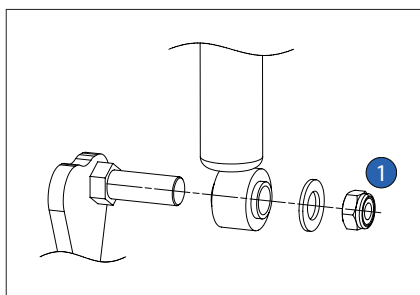

# MOUNTING INSTRUCTIONS

9

Prior assembling the Öhlins shock absorber on the motorcycle, install :

- The OEM nut on the top stud.
- The Lower OEM bushing on the top stud.
- The OEM washer on the lower end eye.

**Diagram 4**

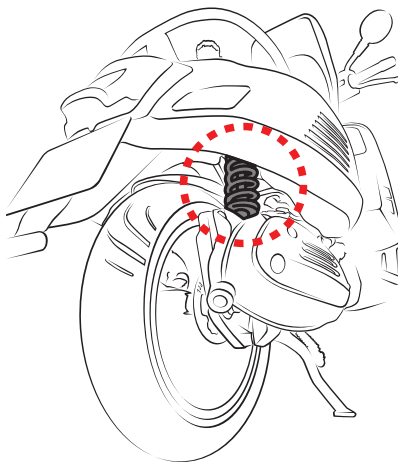
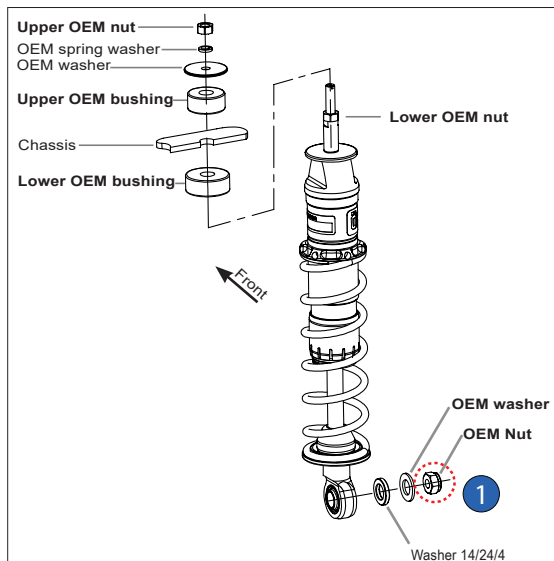

Tighten the nut ① and upper OEM nut at a torque value as per Vespa service manual instructions..

10

Reverse all the procedures as necessary.

# ADJUSTMENTS

## ⚠ Warning!

Before riding, always make sure that the basic settings made by Öhlins are according to recommended Set-up Data. Read about adjustments and setting up in the Öhlins Owner's Manual before you make any adjustments. Contact an Öhlins dealer if you have any questions about setting up.

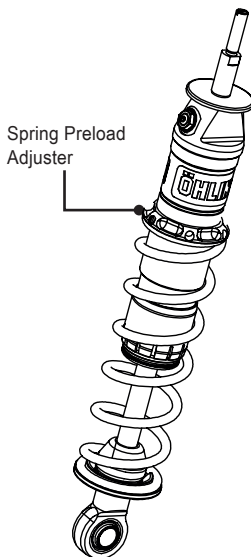

## SET-UP DATA

Recommended set-up	LH	RH
Spring Preload	13 mm	13 mm

Shock absorber data	LH	RH
Length	328 mm	324 mm
Stroke	88 mm	84 mm

Spring	LH	RH
Part No.	60360-03	60360-03
Free spring length	200 mm	200 mm
Spring rate	prog 14-21 N/mm	prog 14-21 N/mm
Preload adjustment range	[8-32]	[8-32]mm

👁 Öhlins products are subject to continuous improvement and development, therefore, although these instructions include the most up-to-date information available at the time of printing, minor updates may occur.

To find the latest information contact an Öhlins distributor. Please contact Öhlins if you have any questions regarding the contents in this document.

Part no. MI\_PI 902\_EN\_0  
Issued 2019-10-26

© Öhlins Asia Co. Ltd. All rights reserved. Any reprinting or unauthorized use without the written permission of Öhlins Racing AB is prohibited.

Öhlins Asia Co. Ltd  
700/937 Moo5, Tambol Nongkhaga,  
Amphur Phantong, Chonburi Province  
20160 Thailand



[www.ohlins.com](http://www.ohlins.com)